

Anybus[®] Wireless Bridge II[™]

USER MANUAL

SCM-1202-032 2.4 en-US ENGLISH



Important User Information

Disclaimer

The information in this document is for informational purposes only. Please inform HMS Networks of any inaccuracies or omissions found in this document. HMS Networks disclaims any responsibility or liability for any errors that may appear in this document.

HMS Networks reserves the right to modify its products in line with its policy of continuous product development. The information in this document shall therefore not be construed as a commitment on the part of HMS Networks and is subject to change without notice. HMS Networks makes no commitment to update or keep current the information in this document.

The data, examples and illustrations found in this document are included for illustrative purposes and are only intended to help improve understanding of the functionality and handling of the product. In view of the wide range of possible applications of the product, and because of the many variables and requirements associated with any particular implementation, HMS Networks cannot assume responsibility or liability for actual use based on the data, examples or illustrations included in this document nor for any damages incurred during installation of the product. Those responsible for the use of the product must acquire sufficient knowledge in order to ensure that the product is used correctly in their specific application and that the application meets all performance and safety requirements including any applicable laws, regulations, codes and standards. Further, HMS Networks will under no circumstances assume liability or responsibility for any problems that may arise as a result from the use of undocumented features or functional side effects found outside the documented scope of the product. The effects caused by any direct or indirect use of such aspects of the product are undefined and may include e.g. compatibility issues and stability issues.

Table of Contents

Page

1	Preface	3
1.1	About This Document	3
1.2	Document Conventions	3
1.3	Trademarks	3
2	Safety	4
2.1	General Safety Instructions	4
2.2	External Antenna Restrictions	4
2.3	Intended Use	4
2.4	Type Identification	4
3	Installation	5
3.1	General Information	5
3.2	Limitations	5
3.3	Mechanical Installation	6
3.4	Connectors	7
3.5	LED Indicators	8
3.6	MODE Button	10
4	Configuration	11
4.1	General	11
4.2	Easy Config	11
4.3	Web Interface	12
4.4	Factory Restore	28
A	Configuration Examples	29
A.1	Ethernet Bridge via WLAN or Bluetooth® (Easy Config)	29
A.2	PROFINET networking via Bluetooth®	30
A.3	EtherNet/IP™ Networking via Bluetooth®	31
A.4	Ethernet network to existing WLAN	32
A.5	Adding single Ethernet node to WLAN	34
A.6	Accessing PLC via WLAN from Handheld Device	35
B	Technical Data	37
B.1	Hardware Specifications	37
B.2	Communication	38
B.3	Internal Antenna Characteristics	39
C	Wireless Technology Basics	44

This page intentionally left blank

1 Preface

1.1 About This Document

This document describes how to install and configure Anybus Wireless Bridge II.

For additional documentation and software downloads, FAQs, troubleshooting guides and technical support, please visit www.anybus.com/support.

1.2 Document Conventions

Numbered lists indicate tasks that should be carried out in sequence:

1. First do this
2. Then do this

Bulleted lists are used for:

- Tasks that can be carried out in any order
- Itemized information
- ▶ An action
 - and a result

User interaction elements (buttons etc.) are indicated with bold text.

```
Program code and script examples
```

Cross-reference within this document: [Document Conventions, p. 3](#)

External link (URL): www.hms-networks.com



WARNING

Instruction that must be followed to avoid a risk of death or serious injury.



Caution

Instruction that must be followed to avoid a risk of personal injury.



Instruction that must be followed to avoid a risk of reduced functionality and/or damage to the equipment, or to avoid a network security risk.



Additional information which may facilitate installation and/or operation.

1.3 Trademarks

Anybus® is a registered trademark and Wireless Bridge II™ is a trademark of HMS Industrial Networks AB. All other trademarks mentioned in this document are the property of their respective holders.

2 Safety

2.1 General Safety Instructions



Caution

This equipment emits RF energy in the ISM (Industrial, Scientific, Medical) band. Make sure that all medical devices used in proximity to this equipment meet appropriate susceptibility specifications for this type of RF energy.



This equipment is recommended for use in both industrial and domestic environments. For industrial environments it is mandatory to use the functional earth connection to comply with immunity requirements. For domestic environments the functional earth must be used if a shielded Ethernet cable is used, in order to meet emission requirements.



This equipment contains parts that can be damaged by electrostatic discharge (ESD). Use ESD prevention measures to avoid damage.

2.2 External Antenna Restrictions

For models with external antenna, only use antennas that are certified for use with this equipment. Using external antennas that are not certified for use with this equipment will invalidate its certifications and make it non-compliant with the regulations for radio equipment.

A list of certified antennas can be found at www.anybus.com/support.

2.3 Intended Use

The intended use of this equipment is as a communication interface and gateway. The equipment receives and transmits data on various physical levels and connection types.

If this equipment is used in a manner not specified by the manufacturer, the protection provided by the equipment may be impaired.

2.4 Type Identification

The type name consists of a type prefix followed by two designators for interface configuration and functionality.

Prefix	AWB3	Anybus Wireless Bridge II
Interface configuration	A B	Internal antenna, Dual M12 External antenna, Dual M12, RP-SMA
Functionality	A B	Ethernet with digital input Ethernet w/o digital input

Example: AWB3AA = Anybus Wireless Bridge II with internal antenna, Ethernet networking and digital input.

3 Installation

3.1 General Information

Make sure that you have all the necessary information about the capabilities and restrictions of your local network environment before installation.

For models with internal antenna the characteristics of the antenna should be considered when choosing the placement and orientation of the unit.

For optimal reception, wireless devices require a zone between them clear of objects that could otherwise obstruct or reflect the signal. A minimum distance of 50 cm between the devices should also be observed to avoid interference.

See also [Wireless Technology Basics, p. 44](#).

3.2 Limitations

Bluetooth PAN (Personal Area Network) may not work with some devices due to different implementations of Bluetooth by different manufacturers.

WLAN 5 GHz cannot be used at the same time as WLAN 2.4 GHz or Bluetooth.

3.3 Mechanical Installation

Anybus Wireless Bridge II can be screw-mounted directly onto a flat surface or mounted on a standard DIN rail using the optional DIN mounting kit.

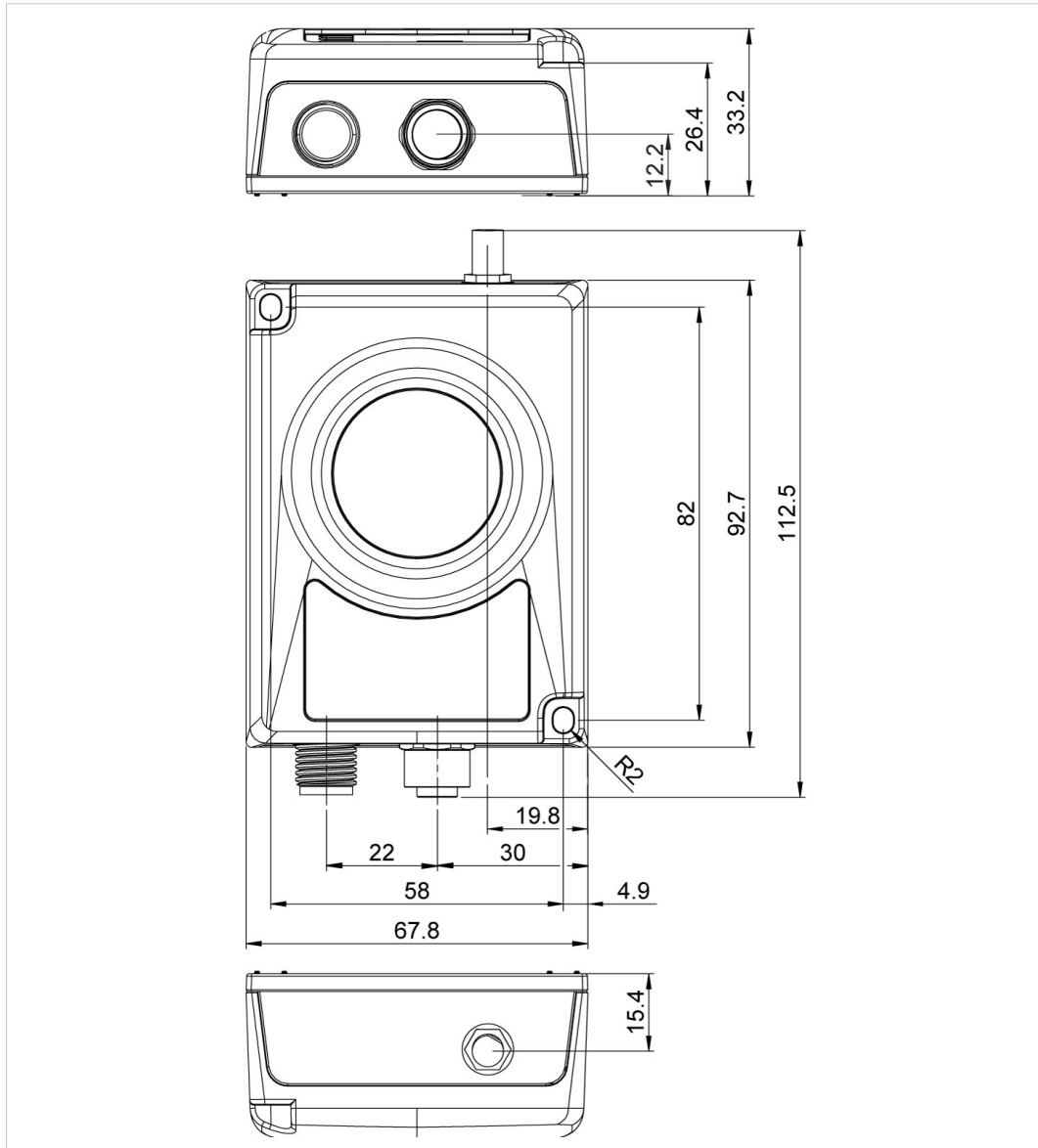

Fig. 1 Installation drawing

All measurements are in mm.

3.4 Connectors

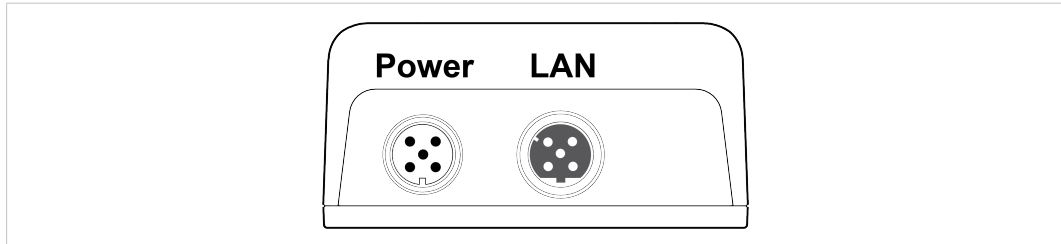

Fig. 2 M12 connectors

Power Connector (A-coded male M12)

	Pin	Function
	1	Power + (9–30 V)
	2	Digital Input Ground
	3	Power Ground
	4	Digital Input + (9–30 V)
	5	Functional Earth

The digital input can be used for additional functionality with advanced configurations and to remotely reset the unit.

! If voltage is applied to the digital input for more that 10 seconds the unit will be reset to factory defaults.

! Signal wiring for the digital input must be carried in the same cable as power and functional earth if wiring length exceeds 3 meters.

See www.anybus.com/support for more information about the digital input.

LAN Connector (D-coded female M12)

	Pin	Function	Color coding (T568B)
	1	Transmit +	Orange/White
	2	Receive +	Green/White
	3	Transmit -	Orange
	4	Receive -	Green

3.5 LED Indicators

3.5.1 Status Indicators

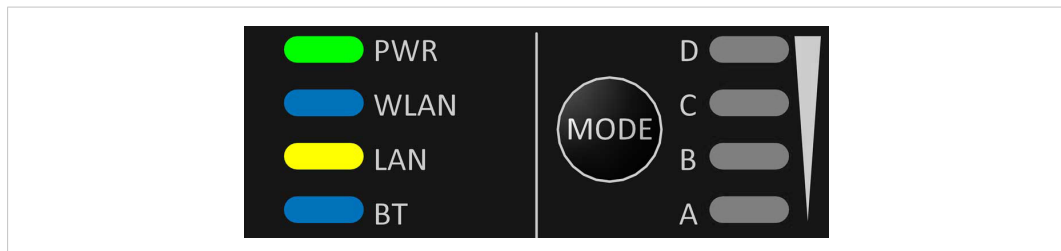

Fig. 3 Status LED indicators

LED Indication		Description
PWR	Off	No power
	Green	Normal operation
WLAN	Off	WLAN disabled or no power
	Blue, blinking	Access Point: No clients, awaiting connections
	Blue	Access Point: Connected to at least one client Client: Connected to access point
	Blue, flickering	WLAN data activity (when connected)
	Purple, blinking	Client: Scanning for access points
	Purple	Client: Connecting to a detected access point
	Red	Unrecoverable error
LAN	Off	No Ethernet connection
	Yellow	Ethernet link present
	Yellow, flickering	Ethernet data activity (when connected)
BT	Off	Bluetooth disabled or no power
	Blue, blinking	NAP: No clients, awaiting connections
	Blue	NAP: Connected to at least one PANU client PANU: Connected to NAP
	Blue, flickering	Bluetooth data activity (when connected)
	Purple	PANU: Trying to connect to NAP
	Red	Unrecoverable error

3.5.2 Link Quality/Mode Indicators

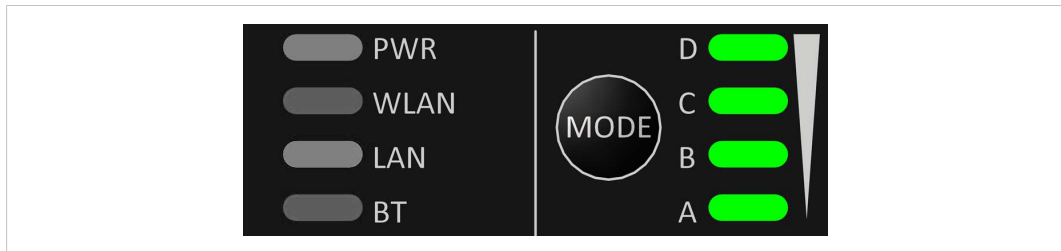

Fig. 4 Link Quality/Mode indicators

RSSI (WLAN Client) / Link Quality (Bluetooth PANU)				
LED				Description
				No connection
A				RSSI/Link Quality < 25 %
A	B			RSSI/Link Quality 25–50 %
A	B	C		RSSI/Link Quality 50–75 %
A	B	C	D	RSSI/Link Quality > 75 %

These LEDs are also used when selecting an Easy Config mode and to indicate update status in Recovery Mode.

See [Easy Config, p. 11](#) and [Recovery Mode LED Indications, p. 10](#).

3.6 MODE Button

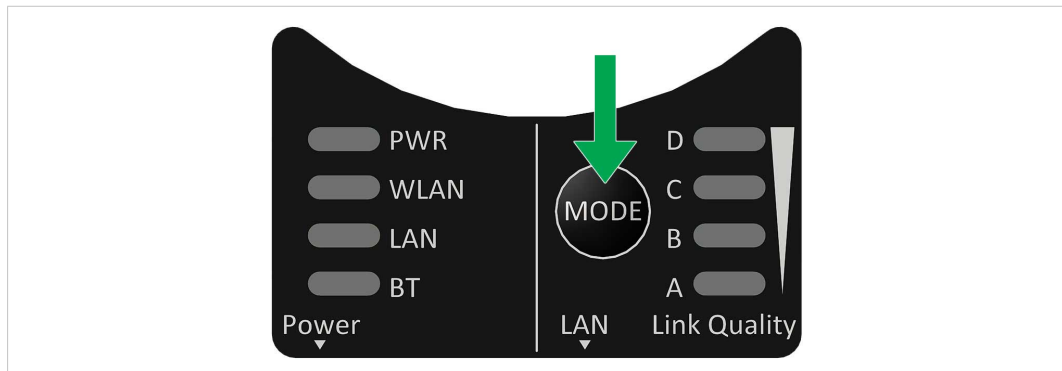

Fig. 5 MODE button

The **MODE** button can be used to restart or reset the unit as well as for selecting an Easy Config mode.

When the unit is powered on, press and hold **MODE** for >10 seconds and then release it to reset to the factory default settings.

Recovery Mode

If the web interface cannot be accessed, the unit can be reset by starting in *Recovery Mode* and reinstalling the firmware using Anybus Firmware Manager II, which can be downloaded from www.anybus.com/support.

To enter Recovery Mode, press and hold **RESET** during startup.



Firmware updates should normally be carried out through the web interface. Recovery Mode should only be used if the unit is unresponsive and the web interface cannot be accessed.

Recovery Mode LED Indications

In Recovery Mode the Status LEDs will indicate firmware update status:

PWR	Green	Firmware update in progress
	Green, blinking	Waiting for valid firmware
WLAN + BT	Alternating red/blue	Firmware update in progress

4 Configuration

4.1 General

Anybus Wireless Bridge II can be configured via the web interface or using one of the pre-configured **Easy Config** modes.

Advanced configuration can be carried out by issuing AT (modem) commands through the web interface or over a Telnet or RAW TCP connection to port 8080. For more information about using AT commands, please refer to the *AT Commands Reference Guide*.

4.2 Easy Config

1. Power on the unit and wait for the **Link Quality** LEDs to light up and go out again, then immediately press and release the **MODE** button.
2. Press **MODE** repeatedly to cycle through the Easy Config modes until the desired mode is indicated by the **A-B-C-D** LEDs.
3. Within 20 seconds of step 2, press and hold **MODE** for 2 seconds. When the button is released the unit will restart in the selected mode.

4.2.1 Easy Config Modes

EC	LED				Role	Description
1	A				Bluetooth PANU	Configure as a client and scan for another client (PANU to PANU).
2		B			–	Reset configuration to factory defaults.
3	A	B			–	Reset IP settings to factory defaults.
4			C		Client	Wait for automatic configuration.
5	A		C		WLAN AP	Configure units in mode 4 as clients.
6		B	C		Bluetooth NAP	Restart as access point and connect clients.
7	A	B	C		WLAN AP	Configure units in mode 4 as clients. Restart as access point and connect clients.
8				D	Bluetooth NAP	Apply PROFINET optimization to all units.
9	A			D	Bluetooth PANU	Configure as a client and scan for another client (PANU to PANU). Apply PROFINET optimization to both units.
10		B		D (any)	(any)	Apply PROFINET optimization and restart.
11	A	B		D (any)	(any)	Enable PROFIsafe mode.

The Easy Config modes are also described when selected in the web interface.

4.3 Web Interface

4.3.1 System Overview

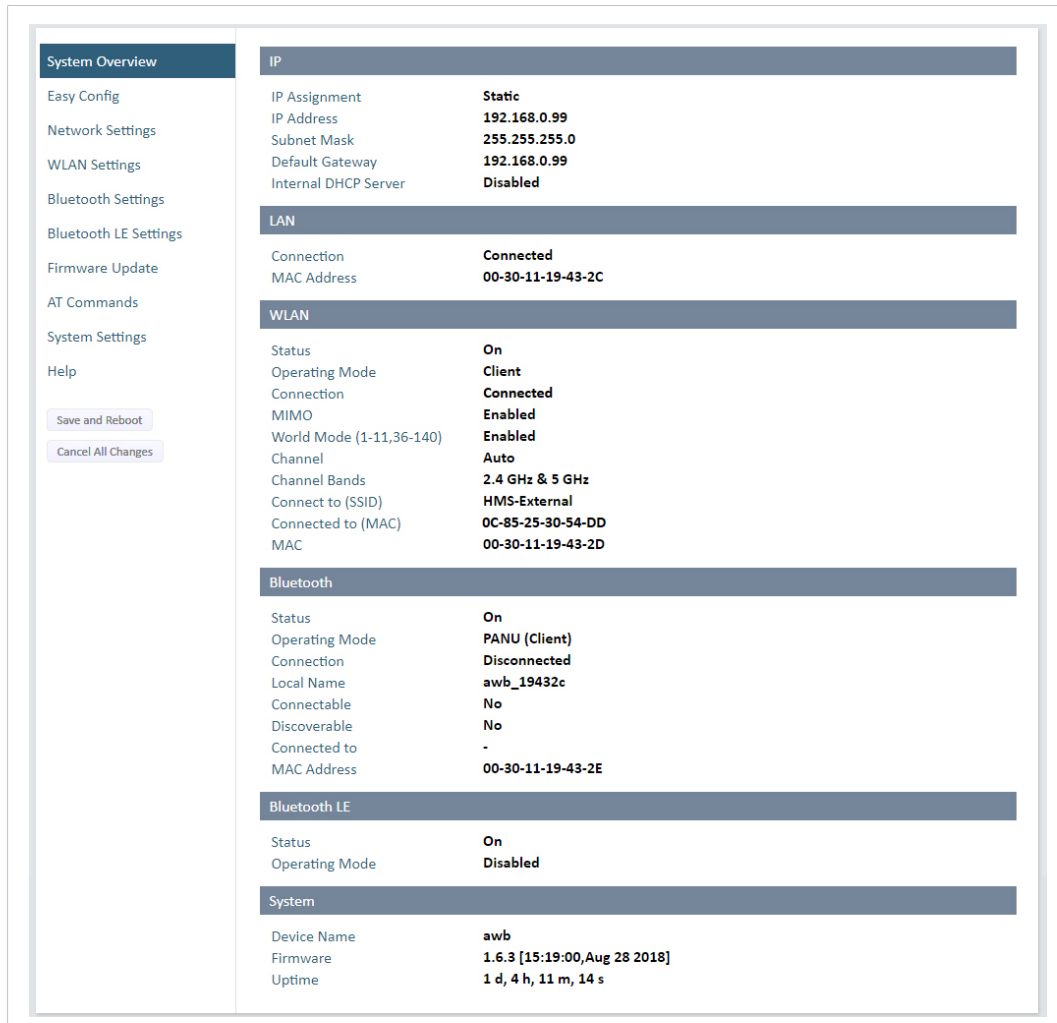

Fig. 6 System Overview page

The **System Overview** page shows the current settings and connection status for the wired and wireless interfaces. The different parameters are explained in the descriptions of each settings page in this manual.

The **Help** page describes AT commands that can be used for advanced configuration.

Save and Reboot This button will be enabled if the unit must be restarted to apply a change.

Cancel All Changes Resets parameter changes that have not been applied.

4.3.2 Easy Config

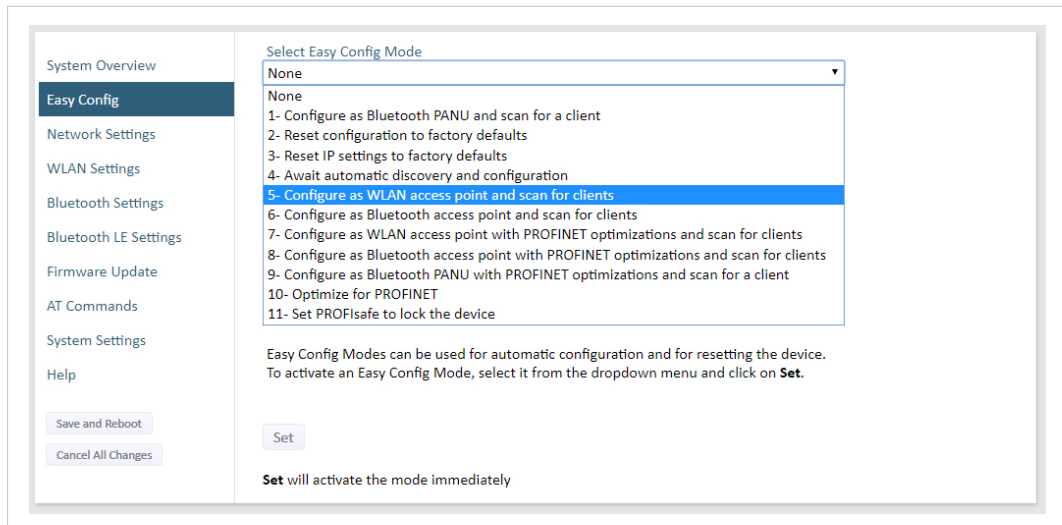

Fig. 7 Easy Config page

To activate an Easy Config mode, select it from the dropdown menu and click on **Set**. The mode will be activated immediately.

Easy Config Modes		
EC	Role	Description
1	Bluetooth PANU	Configure as Bluetooth client and scan for another client (PANU–PANU).
2	–	Reset configuration to factory defaults.
3	–	Reset IP settings to factory defaults.
4	Client	Wait for automatic configuration. Configure units in mode 4 as clients.
5	WLAN AP	Configure units in mode 4 as clients.
6	Bluetooth NAP	Restart as access point and connect clients.
7	WLAN AP	Restart as access point and connect clients.
8	Bluetooth NAP	Apply PROFINET optimization to all units.
9	Bluetooth PANU	Configure as Bluetooth client and scan for another client (PANU–PANU). Apply PROFINET optimization to both units.
10	(any)	Apply PROFINET optimization and restart.
11	(any)	Enable PROFIsafe mode.

Notes:

- Mode 1 will scan for units in mode 4. When a unit in mode 4 is detected, the scanning unit will configure itself as a Bluetooth PANU client, send a connection configuration to the detected unit, and restart. The detected unit will also restart and attempt to connect to the first unit as a PANU client.
- Modes 5, 6, 7 and 8 will scan for units in mode 4. The detected units will be reconfigured as clients and the scanning unit will restart as an access point. The clients will then restart and connect to the access point.
- Modes 7 and 8 will additionally apply PROFINET optimization to all the units. PROFINET messages will then have priority over TCP/IP frames.
- Mode 11 locks the unit in PROFIsafe mode where the configuration cannot be changed without physical access. To cancel this mode the unit must be restored to factory defaults by pressing and holding the MODE button.
- Modes 10 and 11 will be added to the configuration without changing any other settings.
- Modes 1 and 9 will listen for 40 seconds or until a configuration is established.
- Modes 4 will listen for 120 seconds or until receiving a configuration.
- Modes 5, 6, 7 and 8 will time out after 120 seconds.

4.3.3 Network Settings

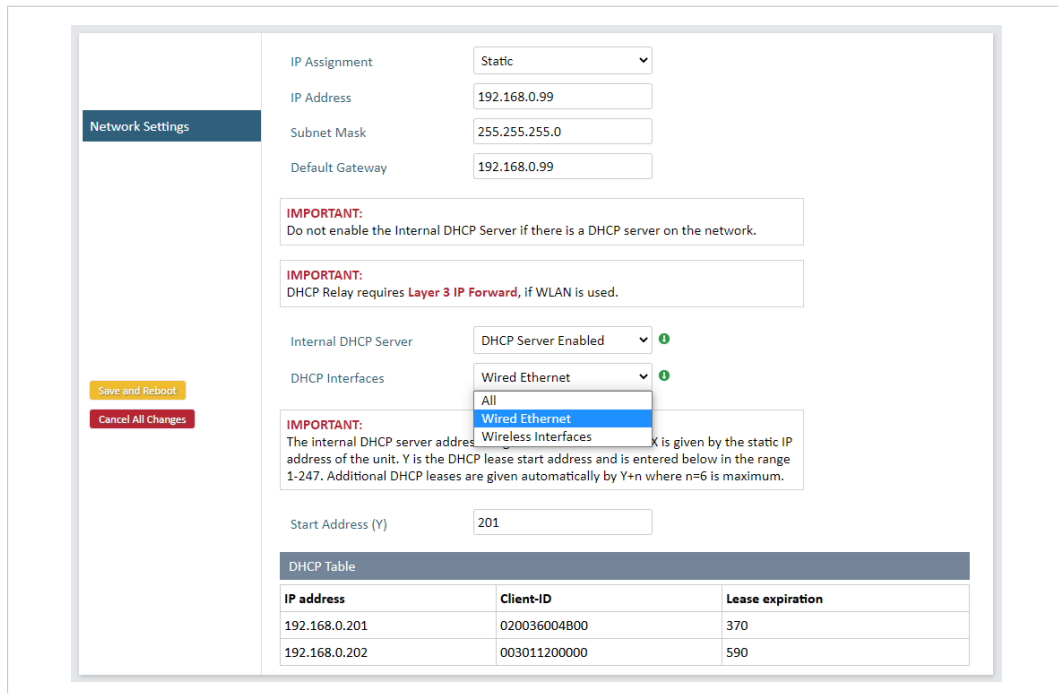

Fig. 8 Network Settings page

- IP Assignment** Select static or dynamic IP addressing (DHCP)
- IP Address** Static IP address for the unit
The browser should automatically be redirected to the new address after clicking on **Save and Reboot** (not supported by all browsers).
- Subnet Mask** Subnet mask when using static IP
- Default Gateway** Default gateway when using static IP
- Internal DHCP Server** **Disabled:** No internal DHCP functionality
DHCP Relay Enabled: The unit can receive a DHCP request on one interface and resend it to a DHCP server located on one of the other interfaces.
Only a single DHCP server can be active for all the connected interfaces.
If WLAN is used, the forwarding mode must be set to Layer 3 IP Forward.
DHCP Server Enabled: Activates an internal DHCP server. This option is only available when IP Assignment is set to Static.
To avoid IP address conflict if a DHCP server is already active on the network, use the **DHCP Interfaces** setting to limit the internal DHCP server to the correct interface.

DHCP Interfaces	The DHCP Interfaces function is available when Internal DHCP Server > DHCP Server Enabled is selected.
	All: By default, the DHCP Interfaces function is set to use all interfaces.
	Wired Ethernet: The internal DHCP server only listens for clients on the wired Ethernet interface.
	Wireless Interfaces: The internal DHCP server listens for clients on all supported wireless interfaces (WLAN/Bluetooth).
Start Address (Y)	The internal DHCP server will assign up to 7 IP addresses starting from X.X.X.Y , where X is taken from the current static IP address setting, and Y is the value in Start Address . Already allocated addresses will be skipped, including the address of the unit itself. The subnet mask setting will be ignored.
	Examples: IP Address: 192.168.0.99, Start Address: 101 DHCP range = 192.168.0.101 – 192.168.0.107 IP Address: 192.168.0.103, Start Address: 101 DHCP range = 192.168.0.101 – 192.168.0.108 7 addresses are allocated but the address of the unit is skipped.

4.3.4 WLAN Settings - Client

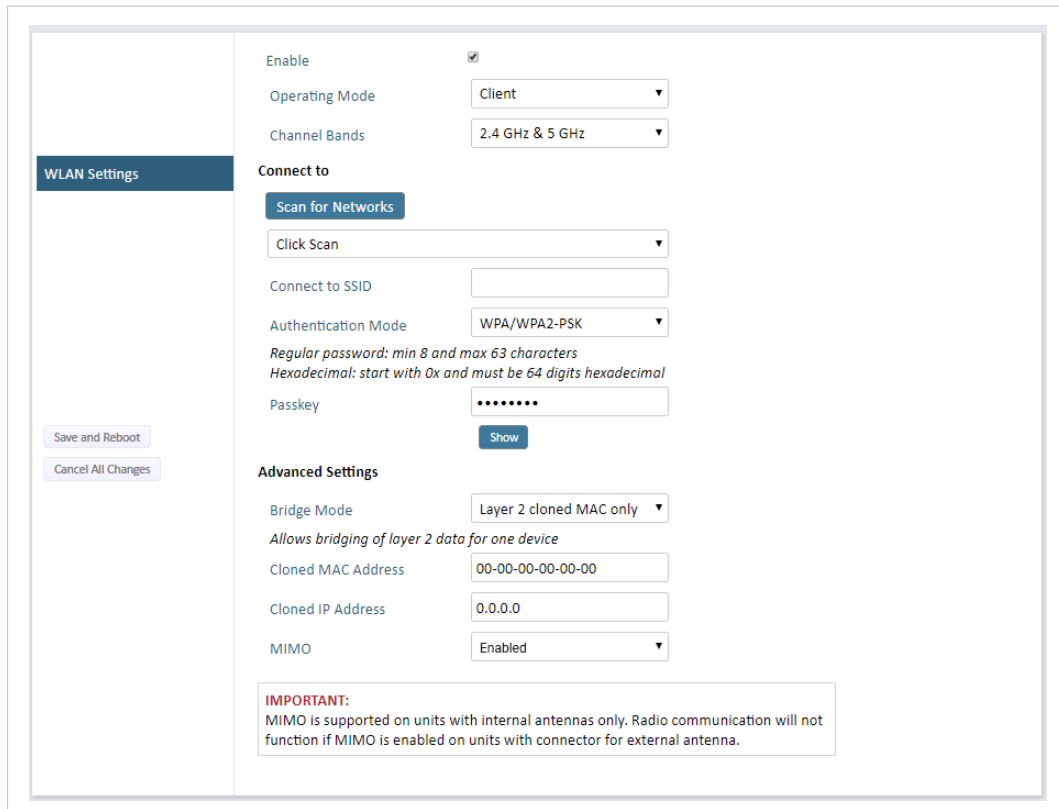

Fig. 9 WLAN Settings - Client

Enable	Enable/disable the WLAN interface.
Operating Mode	Choose operation as WLAN Client or Access Point. If Access Point is selected, additional settings will be available.
Channel Bands	Choose to scan only the 2.4 GHz or 5 GHz channel band, or both (default).

i *The unit can be configured to scan on both the 2.4 GHz and 5 GHz channel bands but can only communicate on one band at a time.*

Scan for Networks	Click to scan the selected frequency band(s) for discoverable WLAN networks. Select a network from the dropdown menu to connect to it.
Connect to SSID	To connect manually to a network, enter its SSID (network name) here. This can be used if the network does not broadcast its SSID.
Authentication Mode	Select the authentication/encryption mode required by the network. Open = No encryption or authentication
Passkey	Enter the passkey when using WPA/WPA2-PSK or WEP64/128.
Username, Domain, Passphrase	Authentication details when using LEAP or PEAP (WPA2 Enterprise).

Advanced Settings

Bridge Mode	<p>Layer 2 tunnel = All layer 2 data will be bridged over WLAN.</p> <p>Use when multiple devices on both sides of an Ethernet network bridge must be able to communicate via WLAN (many-to-many).</p> <p>Only works between Anybus Wireless Bolt or Wireless Bridge II devices.</p> <p>Layer 2 cloned MAC only = Layer 2 data from only a single MAC address (specified below) will be bridged over WLAN (many-to-one).</p> <p>Layer 3 IP forward (default) = IP data from all devices will be bridged over WLAN.</p> <p>This mode must be used when using the DHCP Relay function.</p> <p>When using Layer 3 IP forward in an enterprise network, such as a Cisco Wireless LAN Controller, the connectivity may be reduced.</p> <p>The cause may be:</p> <ul style="list-style-type: none"> • Multiple devices sharing a single wireless interface is not typically supported without special configuration. • The network cannot enforce a 1-to-1 mapping of IP to MAC addresses and must allow propagation of broadcasted ARP messages over the wireless segment in order to route traffic to the bridged devices. <p>If this for security or performance reasons is not acceptable, a setup with a single Ethernet node connected to the Wireless Bridge is recommended.</p>
Cloned MAC Address	The MAC address to use with Layer 2 cloned MAC only (see above).
Cloned IP Address	The IP address to use with Layer 2 cloned MAC only (see above).
MIMO	MIMO (multiple input, multiple output) antenna technology uses multiple antennas for wireless communication in 802.11n.



MIMO is supported on units with internal antennas only. Radio communication will not function if MIMO is enabled on units with connector for external antenna.

WLAN Roaming

Anybus Wireless Bridge II supports Fast Roaming according to IEEE 802.11r. This enables a WLAN client to roam quicker between WLAN Access Points that have the same SSID and support IEEE 802.11r. Fast Roaming is enabled as default but can be permanently disabled using AT commands.

See the *AT Commands Reference Guide* or the **Help** page in the web interface for more information about how to set up WLAN roaming.

WLAN Channels and World Mode (Client Mode only)

Which channels are available for WLAN communication is restricted by the regulatory domain where the unit is operating. Anybus Wireless Bridge II supports regulatory domain detection according to the IEEE 802.11d specification.

The unit is initially set in *World Mode* which enables only the universally allowed channels in the 2.4 GHz and 5 GHz bands (see the table below). World Mode can be disabled and additional channels added using AT commands. The unit will then search for country information during the scan. If the scan indicates that the unit is operating within either the European (ETSI) or North American (FCC) regulatory domains, the additional channels will be enabled. A new scan will be performed every hour to update the regulatory domain.

If no country information or conflicting information is detected, the unit will revert to World Mode. The unit must then be restarted to update the regulatory domain.

See the *AT Commands Reference Guide* or the **Help** page in the web interface for more information about how to use AT commands.

Regulatory domains and WLAN channels

	2.4 GHz	5 GHz
WORLD	1–11	36, 40, 44, 48, 52, 56, 60, 64, 100, 104, 108, 112, 116, 132, 136, 140
ETSI	1–11, 12, 13	36, 40, 44, 48, 52, 56, 60, 64, 100, 104, 108, 112, 116, 120, 124, 128, 132, 136, 140
FCC	1–11	36, 40, 44, 48, 52, 56, 60, 64, 100, 104, 108, 112, 116, 132, 136, 140

Notes

- The maximum output power will be reduced on some channels depending on regulatory requirements.
- WLAN communication may take a longer time to establish during startup if World Mode is disabled and additional channels are used.

4.3.5 WLAN Settings - Access Point

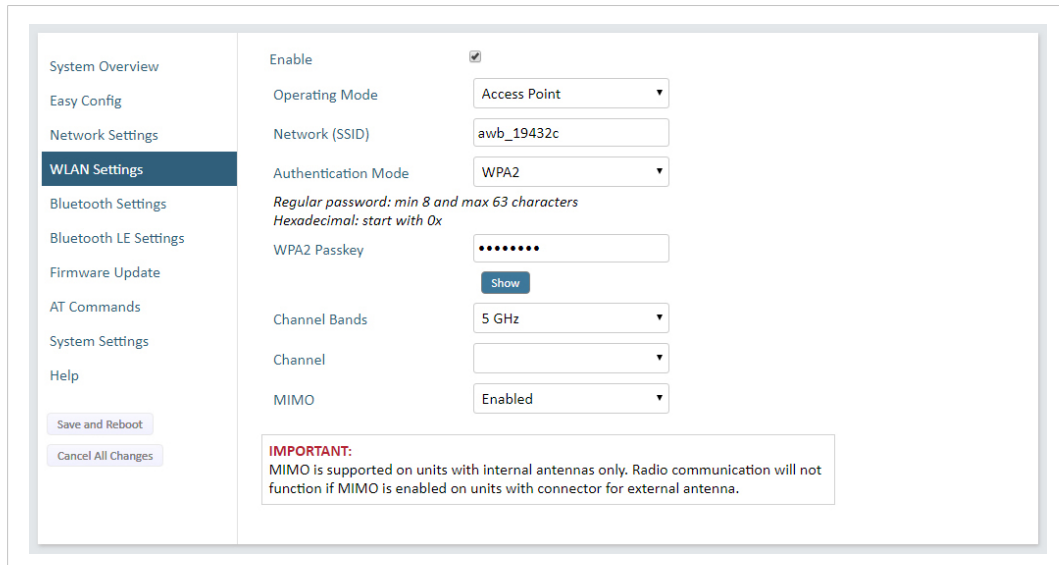

Fig. 10 WLAN Settings - Access Point

The following settings are specific for Access Point mode:

- Network (SSID)** Enter an SSID (network name) for the Wireless Bridge.
If this entry is left blank, the unit will generate an SSID which includes the last 6 characters of the MAC ID.
- Authentication Mode** Select the authentication/encryption mode to use for the access point.
Open = No encryption or authentication
WPA2 = WPA2 PSK authentication with AES/CCMP encryption
- WPA2 Passkey** Enter a string in plain text or hexadecimal format to use for authentication.
Regular (plain text) passwords must be between 8 and 63 characters.
All characters in the ASCII printable range (32–126) are allowed, except " (double quote) , (comma) and \ (backslash).
Hexadecimal passwords must start with 0x and be **exactly** 64 characters.
See also the example passwords below.
- Channel Bands, Channel** Select the WLAN channel band and channel to use for the access point.
Valid channels are 1 to 11 for the 2.4 GHz band and 36, 40, 44, 48 for the 5 GHz band.

Password examples

For plain text passwords a combination of upper and lower case letters, numbers, and special characters is recommended.

Example of a strong plain text password:

uS78_xpa&43

Example of hexadecimal password:

0x000102030405060708090a0b0c0d0e0f101112131415161718191a1b1c1d1e1f

Do not use the example passwords above in a live environment!

4.3.6 Bluetooth Settings – General

Fig. 11 Bluetooth Settings

Enable	Enable/disable the Bluetooth interface.
Operating Mode	<p>PANU (Client) = The unit will operate as a Bluetooth PAN (Personal Area Network) User device. It can connect to another single Bluetooth PANU device or to a Bluetooth Network Access Point.</p> <p>NAP (Access Point) = The unit will operate as a Bluetooth Network Access Point. It can connect to up to 7 Bluetooth PANU devices.</p>
Local Name	Identifies the unit to other Bluetooth devices. If left blank, the unit will use a default name including the last 6 characters of the MAC ID.
Connectable	Enable to make the unit accept connections initiated by other Bluetooth devices.
Discoverable	Enable to make the unit visible to other Bluetooth devices.
Security Mode	<p>Disabled = No encryption or authentication.</p> <p>PIN = Encrypted connection with PIN code security. This mode only works between two units of this type and brand (not with third-party devices). PIN codes must consist of 4 to 6 digits.</p> <p>Just Works = Encrypted connection without PIN code.</p>
Paired Devices	Lists the currently connected Bluetooth devices.

4.3.7 Bluetooth Settings – PANU Mode

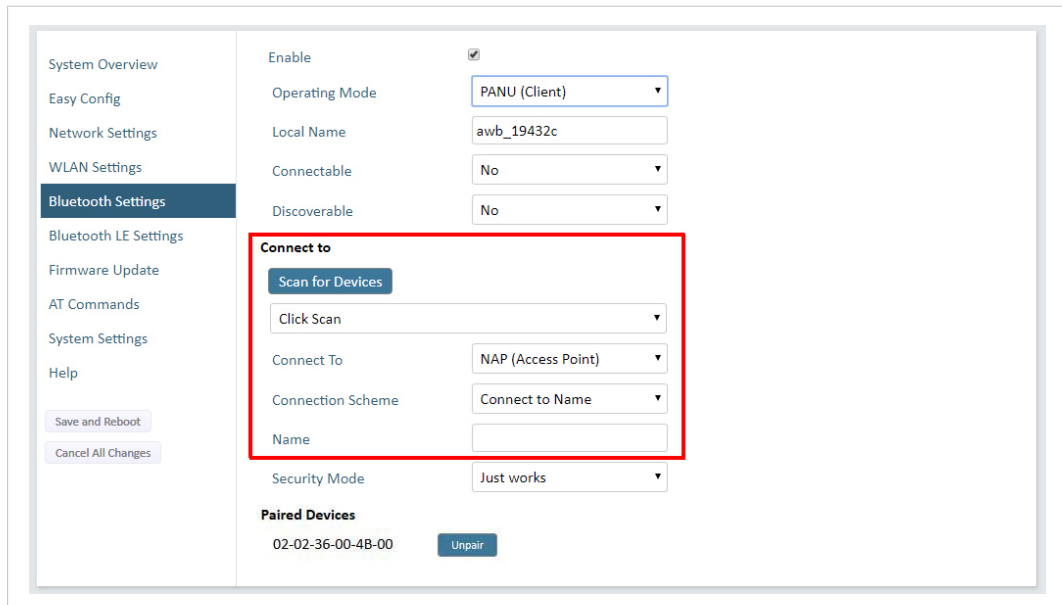

Fig. 12 Bluetooth Settings – PANU

PANU mode only

- Scan for Devices** Scans the network for discoverable Bluetooth devices. To connect to a device, select it from the dropdown menu when the scan has completed.
- Connect To** Used when connecting manually to a NAP or PANU device.
- Connection Scheme** Choose whether to select a Bluetooth device by MAC address (default) or Name when connecting manually.
Connecting to MAC will lock the connection to a specific hardware while connecting to Name allows for more flexibility.
- MAC/Name** MAC address or Name of the Bluetooth device to connect to.

4.3.8 Bluetooth Settings – NAP Mode

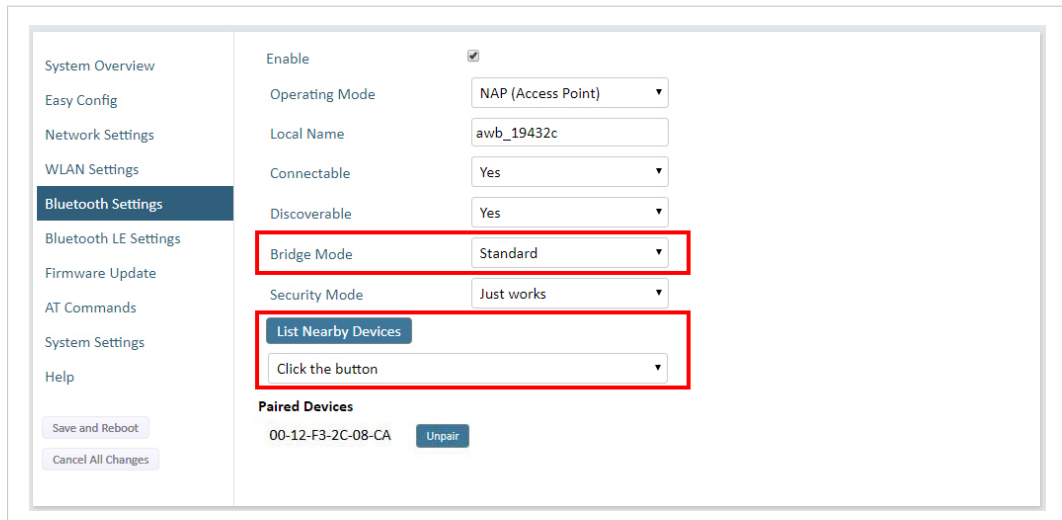

Fig. 13 Bluetooth settings – NAP

NAP mode only

Bridge Mode

Standard = Default mode.

Layer 3 IP forward = IP data will be bridged over Bluetooth.

This mode must be used when connecting to an Android device over Bluetooth. The network must have an active DHCP server.

List Nearby Devices

Scans the network and lists discoverable Bluetooth devices. Pairing cannot be initiated in NAP mode.

4.3.9 Bluetooth LE Settings

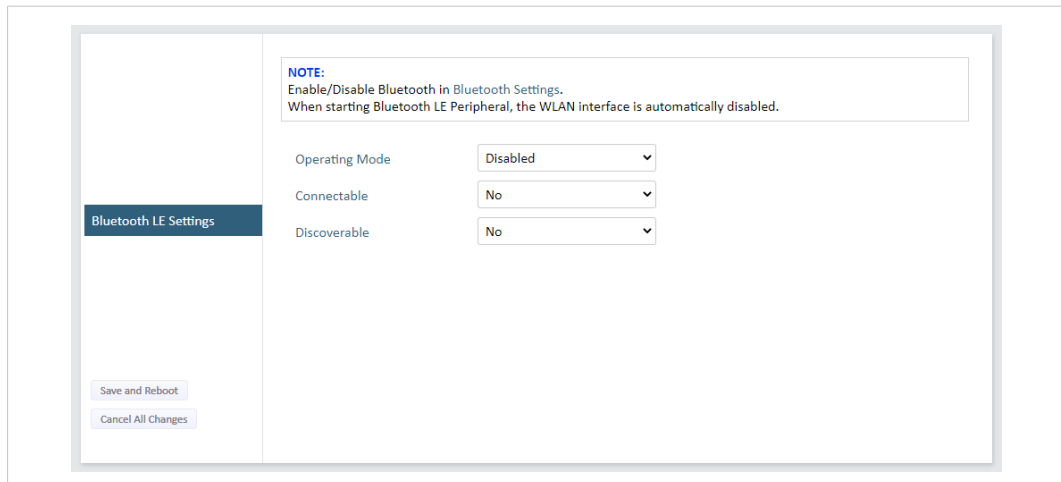

Fig. 14 Bluetooth LE settings

Bluetooth LE Settings

Operating Mode	<p>Disabled = Bluetooth LE disabled (default)</p> <p>Central = Bluetooth LE Central operating mode enabled</p> <p>Peripheral = Bluetooth LE Peripheral operating mode enabled. This requires that the WLAN interface is disabled.</p>
Connectable	<p>No = Connectable is disabled (default)</p> <p>Yes = Enables the Wireless Bridge to search, connect and transfer data with another Bluetooth-capable device.</p>
Discoverable	<p>No = Discoverable is disabled (default)</p> <p>Yes = Enables the Wireless Bridge to pair with another Bluetooth-capable device.</p>

Please refer to the *AT Commands Reference Guide* or select **Help** in the main menu for more information about using Bluetooth LE.



Bluetooth must be enabled on the **Bluetooth Settings** page to use Bluetooth LE.

4.3.10 Firmware Update

To update the firmware in the unit, click on **Browse** to select a downloaded firmware file, then click on **Send** to send it to the unit.

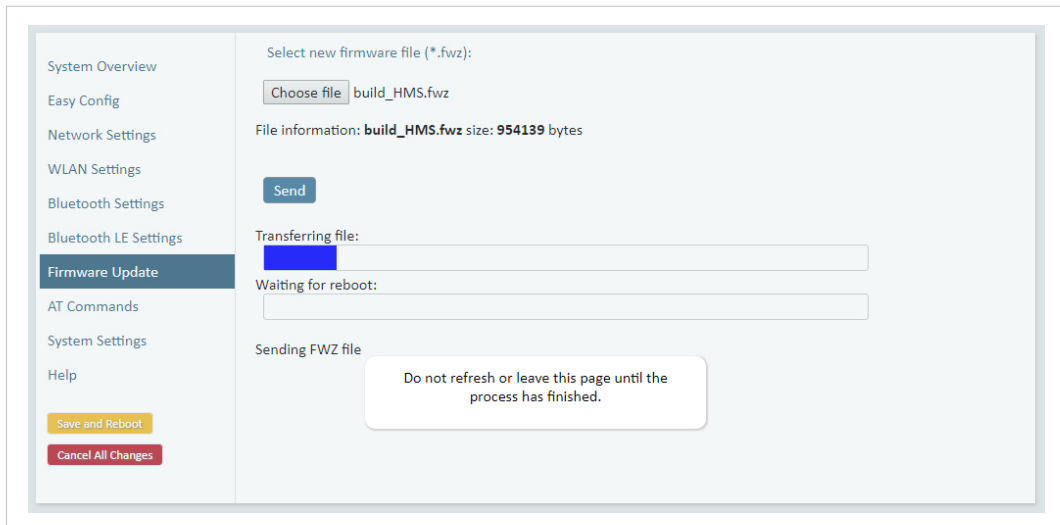

Fig. 15 Firmware update in progress

Both progress bars will turn green when the firmware update has been completed. The unit will then reboot automatically.

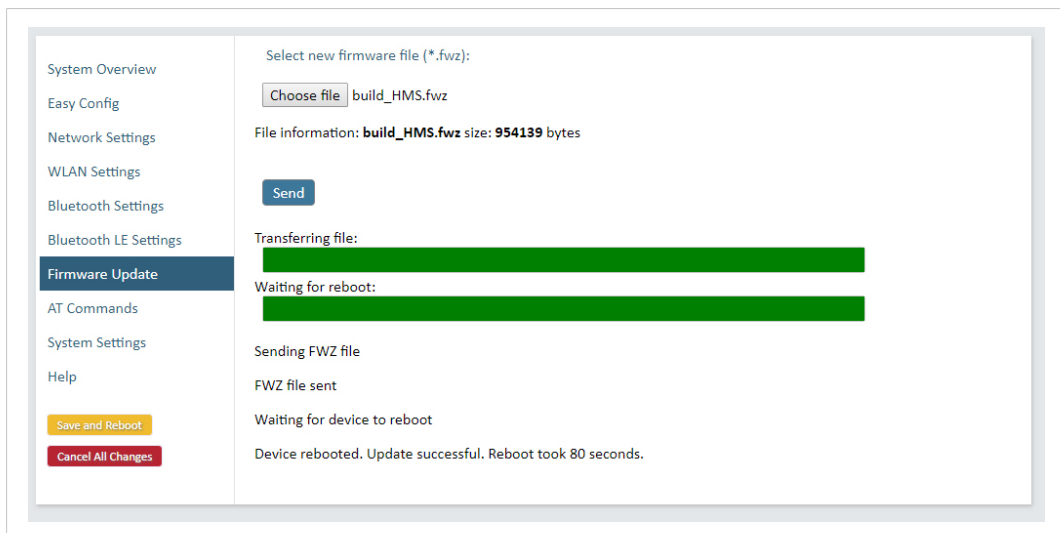

Fig. 16 Firmware update completed

Updating the firmware will not change the configuration settings.

4.3.11 AT Commands

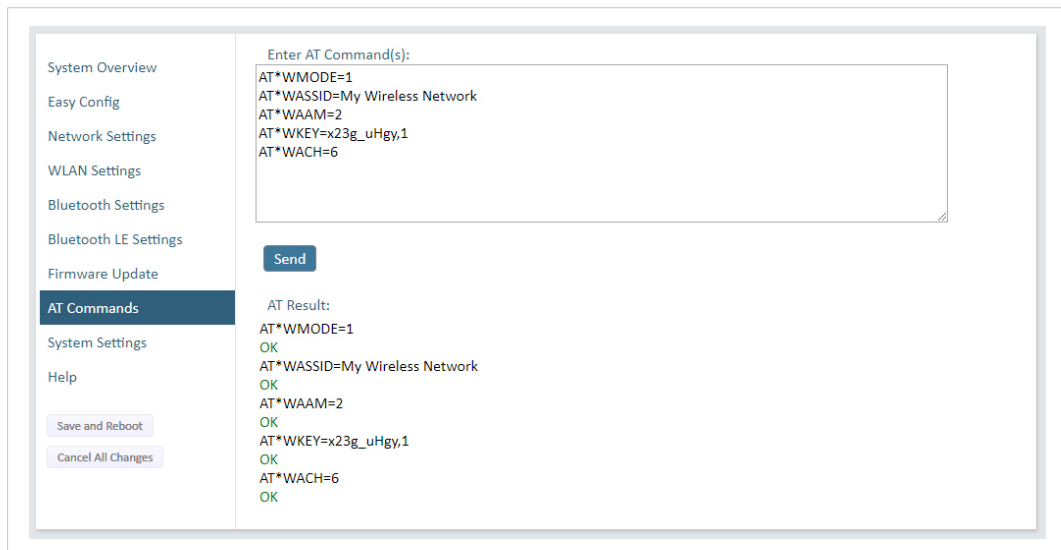

Fig. 17 AT Commands

AT commands can be used for setting advanced parameters that are not accessible in the web interface, to read out parameters in text format, and for batch configuration using command scripts.

Enter or paste the commands into the text box, then click on **Send**. The result codes will be displayed below the text box.

Click on **Help** for a complete list of supported AT commands.

4.3.12 System Settings

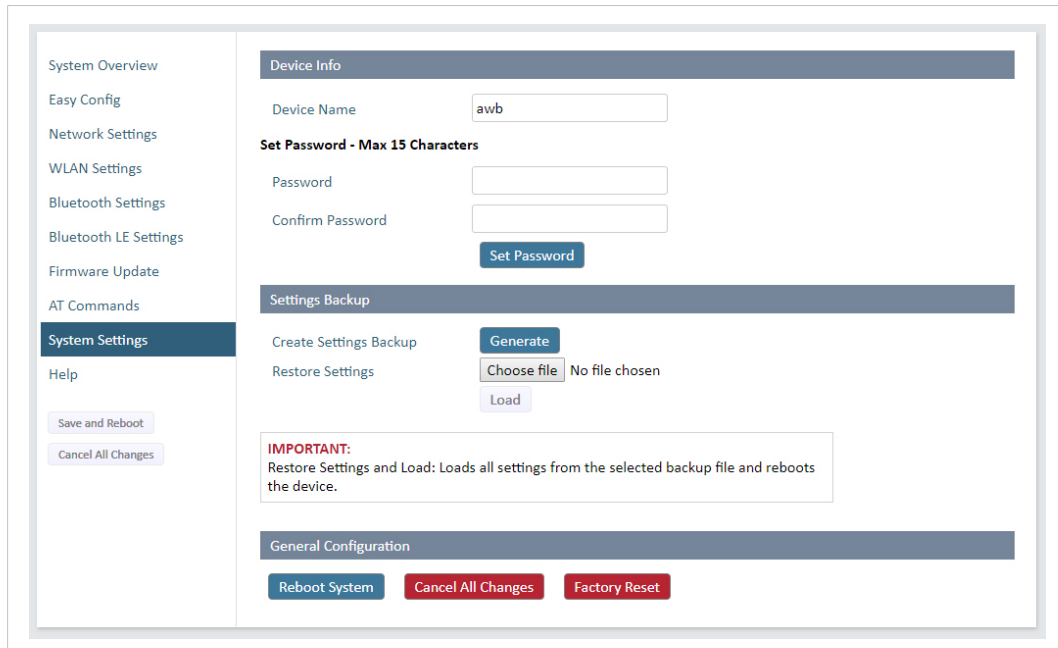

Fig. 18 System Settings

Device Info

- Device Name** Enter a descriptive name for the unit.
- Password** Enter a password for accessing the web interface.
- Reboot System** Reboots the system without applying changes.
- Cancel All Changes** Restores all parameters in the web interface to the currently active values.
- Factory Reset** Resets the unit to the factory default settings and reboots.

Setting a secure password for the unit is strongly recommended.

Settings Backup

- Create Settings Backup** Click on **Generate** to save the current configuration to a file on your computer.
- Restore Settings** Click on **Choose file** and select a previously saved configuration, then click on **Load**. The settings in the saved configuration will be applied and the unit will reboot.

General Configuration

- Reboot System** Reboots the system without applying changes.
- Cancel All Changes** Restores all parameters in the web interface to the currently active values.
- Factory Reset** Resets the unit to the factory default settings and reboots.

4.4 Factory Restore

Any one of these actions will restore the factory default settings:

- Clicking on **Factory Restore** on the **System Settings** page
- Executing **Easy Config Mode 2**
- Issuing the AT command **AT&F** and then restarting the unit
- Holding **MODE** pressed for >10 seconds and then releasing it
- Applying voltage to the digital input for >10 seconds

Default Network Settings	
IP Assignment	Static
IP Address	192.168.0.99
Subnet Mask	255.255.255.0
Default Gateway	192.168.0.99
Internal DHCP Server	Disabled
DHCP Interfaces	All

Default WLAN Settings	
Operating Mode	Client
Channel Bands	2.4 GHz & 5 GHz
Authentication Mode	WPA/WPA2-PSK
Channel	Auto
Bridge Mode	Layer 3 IP forward
MIMO	AWB3000: Enabled AWB3010: Disabled

Default Bluetooth Settings	
Operating Mode	PANU (Client)
Local Name	[generated from MAC address]
Connectable	No
Discoverable	No
Security Mode	Just works
Bluetooth LE	Operating Mode: Disabled Connectable: No Discoverable: No

A Configuration Examples

A.1 Ethernet Bridge via WLAN or Bluetooth® (Easy Config)

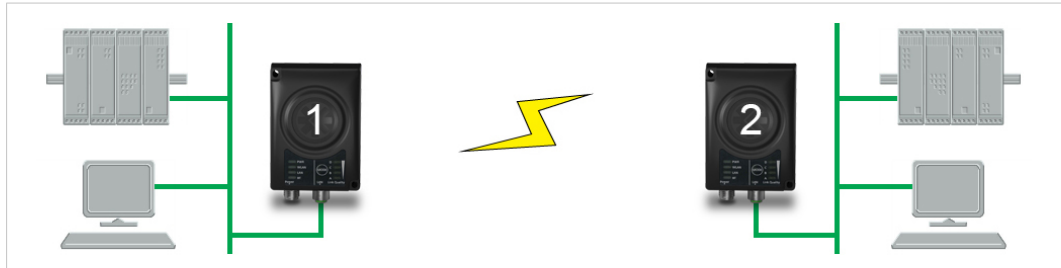

Fig. 19 Ethernet bridge

This example describes how to connect two Ethernet network segments via WLAN or Bluetooth using Easy Config.

Configuration

1. Power on the first unit and wait for the LEDs to light up and go out, then press **MODE** and release it immediately.
2. Press **MODE** repeatedly until only LED **C** is lit (Mode 4), then confirm by pressing and holding **MODE** for 2 seconds.

This unit will now be discoverable and open for automatic configuration.

3. Power on the second unit and wait for the LEDs to light up and go out, then press **MODE** and release it immediately.
4. Press **MODE** repeatedly on the second unit until **A + C** (Mode 5/WLAN) or **B + C** (Mode 6/Bluetooth) are lit, then confirm by pressing and holding **MODE** for 2 seconds.

Unit 2 will now discover and configure unit 1 as a client and configure itself as an access point. Unit 1 will be assigned the first free IP address in the same Ethernet subnet as unit 2.

Adding More Devices

Up to 6 additional clients can be added by repeating the procedure. Each new client will be assigned the next free IP address in the current subnet.

A.2 PROFINET networking via Bluetooth®

Configuration with Easy Config



Fig. 20 PROFINET wireless network

This example describes how to connect a PROFINET IO device and a PROFINET PLC over Bluetooth using two Wireless Bridges and Easy Config.

The Wireless Bridges will be configured with PROFINET optimization, which means that PROFINET messages will have priority over TCP/IP frames.

See the respective documentation for the IO device and PLC on how to configure them for PROFINET communication.

Configuration

1. Reset both Wireless Bridges to the factory default settings.
2. Connect Wireless Bridge 1 to the IO device and Wireless Bridge 2 to the PLC.
3. Set Wireless Bridge 1 to Easy Config **Mode 4**.

This unit will now be discoverable and open for automatic configuration.

4. Set Wireless Bridge 2 to Easy Config **Mode 8**

This unit should now automatically discover and configure unit 1 as a Bluetooth client, and configure itself as an access point. Both units will be optimized for PROFINET.

The IO device should now be able to communicate with the PLC as if using a wired connection.

Adding More Devices

Up to 6 additional clients can be added by repeating the procedure. Each new client will be assigned the next free IP address within the current subnet.



The IO cycle update time for each IO device must be set to ≥ 64 ms.

A.3 EtherNet/IP™ Networking via Bluetooth®

Configuration with Easy Config



Fig. 21 EtherNet/IP wireless network

This example describes how to connect an EtherNet/IP IO device and an EtherNet/IP PLC over Bluetooth using two Wireless Bridges and Easy Config.

See the respective documentation for the IO device and PLC on how to configure them for EtherNet/IP communication.

Configuration

1. Reset both Wireless Bridges to the factory default settings.
2. Connect Wireless Bridge 1 to the IO device and Wireless Bridge 2 to the PLC.
3. Set Wireless Bridge 1 to Easy Config **Mode 4**.

This unit will now be discoverable and open for automatic configuration.

4. Set Wireless Bridge 2 to Easy Config **Mode 6**

This unit should now automatically discover and configure unit 1 as a Bluetooth client, and configure itself as an access point.

The IO device should now be able to communicate with the PLC as if using a wired connection.

Adding More Devices

Up to 6 additional clients can be added by repeating the procedure. Each new client will be assigned the next free IP address within the current subnet.



The Requested Packet Interval (RPI) for each IO device must be set to ≥ 64 ms.

A.4 Ethernet network to existing WLAN

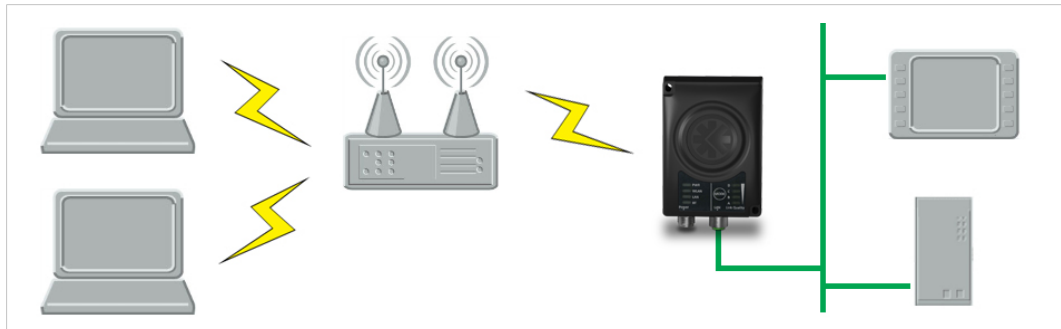

Fig. 22 Connecting to a WLAN

Before You Begin

This example describes how to connect a machine with an internal Ethernet network to an existing WLAN.

This setup allows traffic on network layer 3, but not layer 2. This means that TCP/IP based protocols such as EtherNet/IP, Modbus TCP and BACnet can be used on the WLAN, but not protocols that use layer 2 traffic, such as PROFINET.

When this setup is used in an enterprise network, such as a Cisco Wireless LAN Controller, the connectivity may be reduced.

The cause may be:

- Multiple devices sharing a single wireless interface is not typically supported without special configuration.
- The network cannot enforce a 1-to-1 mapping of IP to MAC addresses and must allow propagation of broadcasted ARP messages over the wireless segment in order to route traffic to the bridged devices.

If this for security or performance reasons is not acceptable, a setup with a single Ethernet node connected to the Wireless Bridge is recommended.

Configuration

1. Reset the Wireless Bridge to the factory default settings.
2. In **Network Settings**, configure the IP settings as required by the wireless network.
3. If the network uses DHCP, select **DHCP Relay Enabled**.

Internal DHCP Server

DHCP Relay Enabled



WLAN Settings for Small Office/Home Office Network

If the setup is used in a small office/home office network, follow these steps:

1. In **WLAN Settings**, click on **Scan for Networks**.
2. When the scan has completed, select the wireless network from the dropdown list.
3. If required, select the authentication mode and enter the passkey for the wireless network.



WLAN Bridge Mode must be set to Layer 3 IP forward (the default setting).

4. Click on **Save and Reboot**.

Result

→ The Ethernet network should now be able to access the WLAN access point.

WLAN Settings for Enterprise Network

If the setup is used in an enterprise network, follow these steps:

1. In **WLAN Settings**, set **Bridge Mode** to **Layer 2 cloned MAC only**.
2. Enter the MAC address of the PLC in the **Cloned MAC Address** field.
3. Enter the IP address of the PLC in the **Cloned IP Address** field.
4. Click on **Save and Reboot**.

Result

→ The Wireless Bridge will now function as a WLAN interface for the PLC using the MAC address of its Ethernet interface.

A.5 Adding single Ethernet node to WLAN



Fig. 23 Adding WLAN connectivity

This example shows how to connect a PLC with an Ethernet network interface to an existing WLAN with support for layer 2 and layer 3 traffic. The WLAN interface in the Wireless Bridge will clone the MAC address of the Ethernet interface in the PLC.

Only a single Ethernet node will be able to communicate via a third-party WLAN access point in this setup.

Configuration

1. Reset the Wireless Bridge to the factory default settings.
2. In **Network Settings**, configure the IP settings as required by the wireless network.
3. In **WLAN Settings**, click on **Scan for Networks**.
4. When the scan has completed, select the wireless network from the dropdown list.
5. If required, select the authentication mode and enter the passkey for the wireless network.
6. Click on **Save and Reboot**.
7. Check the **System Overview** page to confirm that the WLAN connection is established before continuing.
DO NOT SKIP THIS STEP! After the final steps of the configuration procedure the web interface may no longer be accessible from the network without doing a factory reset.
8. In **WLAN Settings**, set **Bridge Mode** to **Layer 2 cloned MAC only**.
9. Enter the MAC address of the PLC in the **Cloned MAC Address** field.
10. Enter the IP address of the PLC in the **Cloned IP Address** field.
11. Click on **Save and Reboot**.

The Wireless Bridge will now function as a WLAN interface for the PLC using the MAC address of its Ethernet interface.

A.6 Accessing PLC via WLAN from Handheld Device

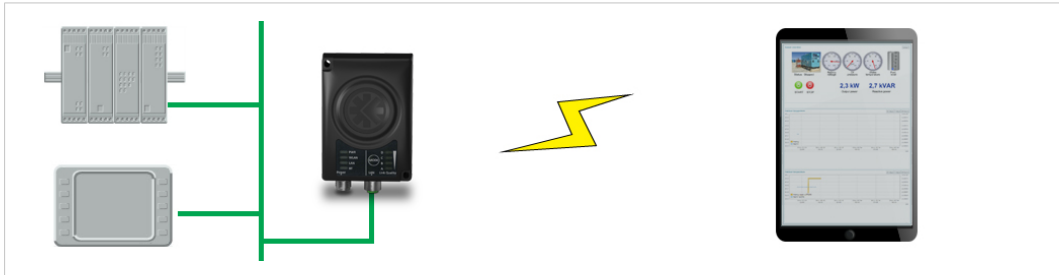

Fig. 24 Accessing a PLC from a handheld device using WLAN

This example describes how to use a Wireless Bridge to access the web interface of a PLC on a wired network from a tablet or smartphone which uses DHCP. The Wireless Bridge will function as a WLAN access point.

Please refer to the documentation for the handheld device and PLC on how to configure their respective network settings.

Configuration

1. Reset the Wireless Bridge to the factory default settings.
2. In **Network Settings**, configure the IP settings as required:

Option if the wired network uses DHCP:

- a. Select **DHCP Relay Enabled**. The DHCP server on the network will now be able to allocate an IP address to the handheld device.

Internal DHCP Server

Option if the wired network uses static IP:

! To avoid IP address conflict if a DHCP server is already active on the network, use the **DHCP Interfaces** setting to limit the internal DHCP server to the correct interface.

- a. Select **DHCP Server Enabled**.
- b. Select an interface from the **DHCP Interfaces** dropdown menu.

Internal DHCP Server ⓘ

DHCP Interfaces ⓘ

- All
- Wired Ethernet
- Wireless Interfaces

- c. Enter a **Start Address** for DHCP addressing. Make sure that the address range does not contain any existing addresses on the network.

Start Address (Y)

- The Wireless Bridge will now function as a DHCP server and allocate an IP address to the handheld device over WLAN.

3. In **WLAN Settings**, set **Operating Mode** to **Access Point**.

The screenshot displays the WLAN Settings interface. On the left, a navigation menu includes System Overview, Easy Config, Network Settings, WLAN Settings (highlighted), Bluetooth Settings, Bluetooth LE Settings, Firmware Update, AT Commands, System Settings, and Help. Below the menu are buttons for 'Save and Reboot' and 'Cancel All Changes'. The main settings area includes: 'Enable' (checked), 'Operating Mode' (Access Point), 'Network (SSID)' (awb_19432c), 'Authentication Mode' (WPA2), 'WPA2 Passkey' (masked with dots and a 'Show' button), 'Channel Bands' (5 GHz), 'Channel' (empty), and 'MIMO' (Enabled). An 'IMPORTANT' warning box at the bottom states: 'MIMO is supported on units with internal antennas only. Radio communication will not function if MIMO is enabled on units with connector for external antenna.'

Fig. 25 WLAN Settings

4. Enter a unique **SSID** (network name) for the new wireless network.
5. Set **Authentication Mode** to **WPA2** and enter a passkey.
6. Select a **Channel band** and a **Channel**.
7. Click on **Save and Reboot**.

You should now be able to connect to the SSID of the Wireless Bridge on your handheld device and access the PLC by entering its IP address in a browser.

B Technical Data

B.1 Hardware Specifications

Order code	AWB3000	AWB3010
Wired Interface type	Ethernet	
Antenna	3 internal antennas: 2.4 GHz 2.4 GHz MIMO 5 GHz	1 external antenna: 2.4 GHz + 5 GHz dual band
Dimensions (LxWxH)	93 x 68 x 33.2 mm	
Weight	120 g	
Operating temperature	-40 to +65 °C	
Storage temperature	-40 to +85 °C	
Humidity	EN 600068-2-78: Damp heat, +40 °C, 93 % humidity for 4 days	
Vibration	See datasheet	
Housing material	Plastic (see datasheet for details)	
Protection class	IP65	
Mounting	Screw mount or DIN rail using optional clip	
Power connector	M12 male A-coded	
Ethernet connector	M12 female D-coded	
Power supply	9–30 VDC (-5 % +20 %) Cranking 12 V (ISO 7637-2:2011 pulse 4) Reverse polarity protection	
Power consumption	0.7 W (idle), 1.7 W (max)	

B.2 Communication

Ethernet	
Ethernet interface	10/100BASE-T with automatic MDI/MDIX auto cross-over detection
Ethernet protocols	IP, TCP, UDP, HTTP, LLDP, ARP, DHCP Client/Server, DNS support Transparent transfer of PROFINET IO, EtherNet/IP, Modbus-TCP or any other TCP/UDP based protocol

Wireless LAN	
Wireless standards	IEEE 802.11 a, b, g, n, d, r
Operation modes	Access point or client
Fast roaming	IEEE 802.11r (client)
Max. number of clients for access point	7
WLAN channels	2.4 GHz Access Point: 1–11 2.4 GHz Client: 1–11 + 12 & 13 depending on regulatory domain scan 5 GHz Access Point: 36–48 (U-NII-1) 5 GHz Client: 36-48 + 100–116, 132–140, 120–128 depending on regulatory domain scan. (U-NII-1, U-NII-2, U-NII-2e)
RF output power	18 dBm EIRP (including max antenna gain 3 dBi)
Power consumption	54 mA @ 24 VDC
Net data throughput	20 Mbps.
Link speed	Max 130 Mbps (802.11n 2x2 MIMO)
Security	WEP 64/128, WPA, WPA-PSK and WPA2, TKIP and AES/CCMP, LEAP, PEAP including MS-CHAP

Classic Bluetooth	
Wireless standards (profiles)	PAN (PANU & NAP)
Operation modes	Access point or Client
Max. number of clients for access point	7
RF output power	14 dBm EIRP (including max antenna gain 3 dBi)
Power consumption	36 mA @ 24 VDC
Net data throughput	~1 Mbps
Bluetooth version support	Classic Bluetooth v2.1
Security	Authentication & Authorization, Encryption & Data Protection, Privacy & Confidentiality, NIST Compliant, FIPS Approved

Bluetooth Low Energy	
Wireless standards (profiles)	GATT
Operation modes	Central or Peripheral (pending)
Max. number of clients for Central	7
RF output power	10 dBm EIRP (including max antenna gain 3 dBi)
Power consumption	36 mA @ 24 VDC
Net data throughput	~200 kbps
Bluetooth version support	Bluetooth 4.0 dual-mode
Security	AES-CCM cryptography

B.3 Internal Antenna Characteristics

Anybus Wireless Bridge II has 3 independent quarter wave monopole antennas: 2.4 GHz MIMO, 5 GHz and 2.4 GHz. The following radiation diagrams show the characteristics of the different antennas as measured under laboratory test conditions. The diagrams can be used as a general guide for finding the optimal placement and orientation of the units.

If using the unit in Bluetooth mode, the 2.4 GHz antenna is used.

B.3.1 Internal Antenna Positions

The placement of the three antennas in the unit is as follows:

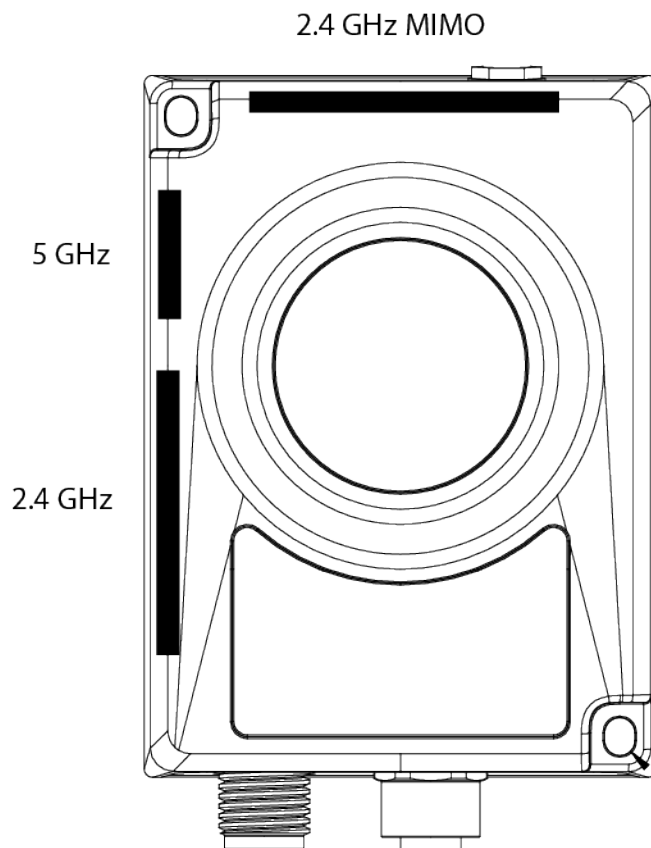

B.3.2 Lab Environment Diagrams

Overview

The following sections contain radiation measurements in different angles. According to the picture below, the Azimuth plane is the horizontal spread of the radiation (A), Elevation 90° is the vertical expansion (B) and Elevation 0° is the front to back expansion (C).

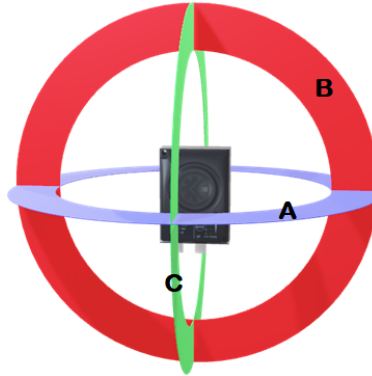

The diagrams show decibel (dB) relative to the Anybus Wireless Bridge II theoretical maximum signal strength. Note that the 2.4 MIMO diagrams show the WLAN usage using both the 2.4 GHz antennas simultaneously (the 2.4 GHz antenna and the 2.4 GHz MIMO antenna).

Azimuth (Horizontal) View

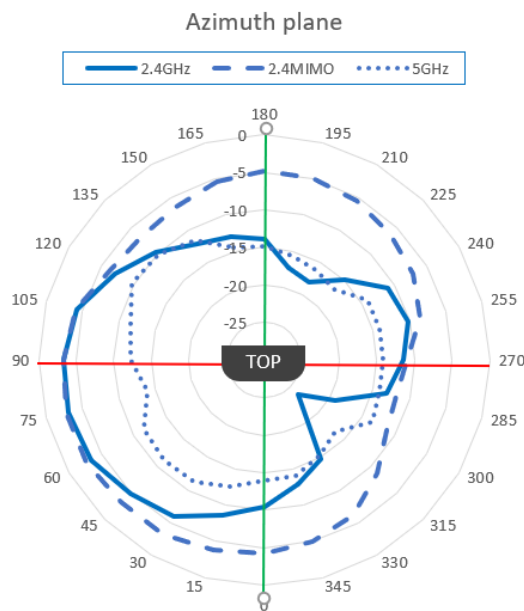

Front View – Elevation (Vertical)

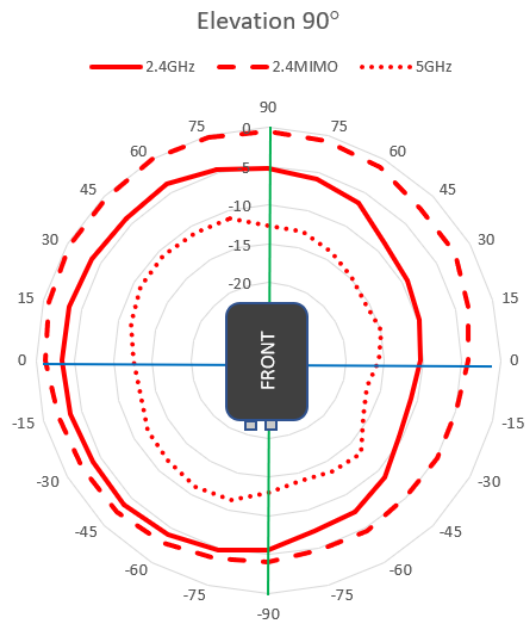

Side View – Elevation (Vertical)

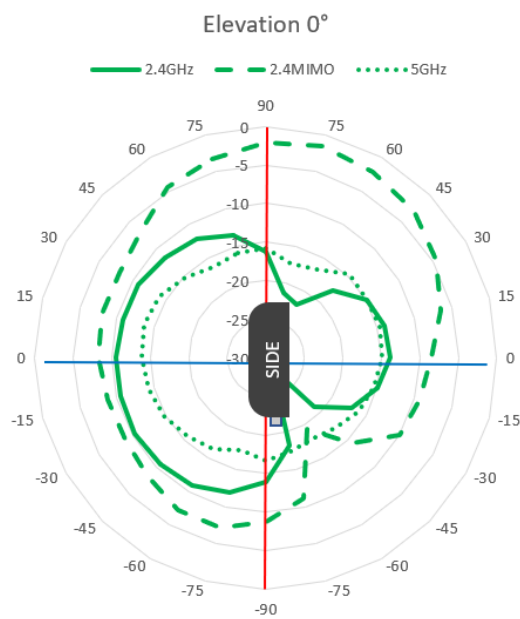

B.3.3 Real World Measurements

Azimuth (Horizontal) View with and without Backshield

This pattern was measured in an outdoor environment, on an open field with no disturbing equipment or radiation. As such it describes how the radio coverage can vary in a real world application. The measurements were set up according to the picture:

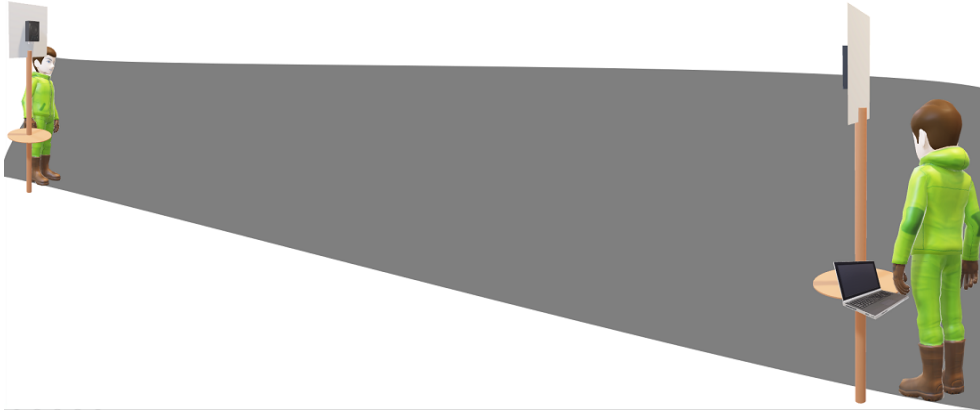

In this example, the measurements are made both with and without backshield. A backshield is a metal surface of at least 300x300 mm, where the Anybus Wireless Bridge II is placed in the center.

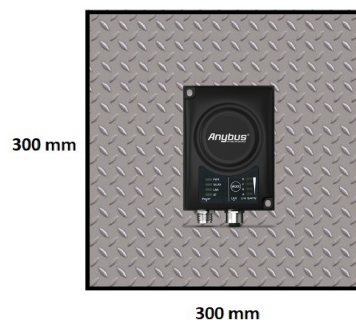

The backshield could be any flat metal surface, like a metal plate or a metal cabinet.

The measurements with backshield clearly shows that the backshield makes it possible to focus the radio energy in any desired direction (away from the backshield).

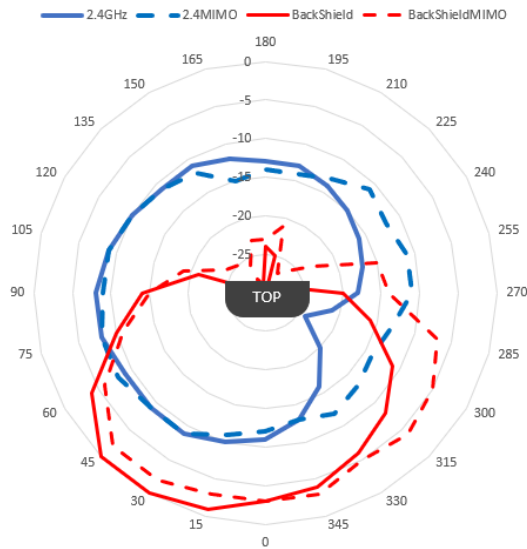

Throughput Diagram

This diagram shows how data throughput decreases when distance increases. Note the huge difference between using a backshield to focus the radio energy, and not using a backshield. Using a backshield can greatly increase radio coverage if used correctly.

The diagram covers both the Anybus Wireless Bridge and the Anybus Wireless Bolt.

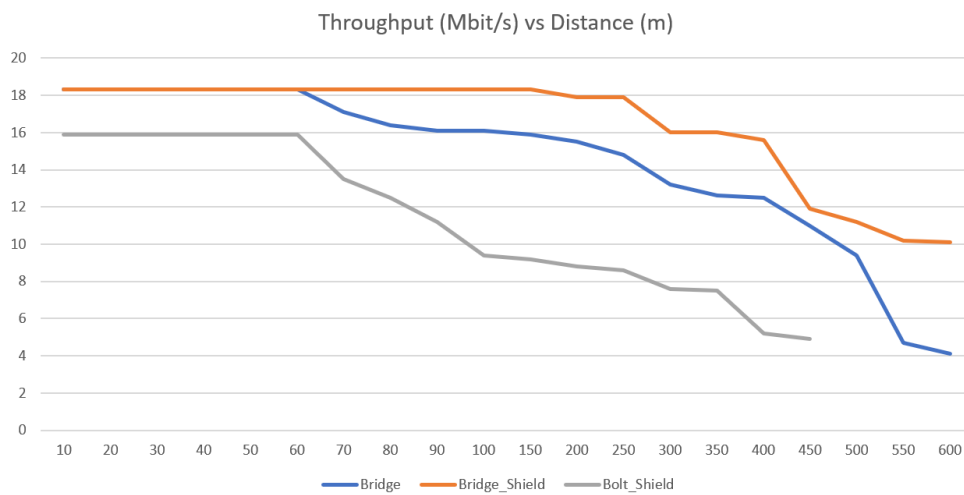

C Wireless Technology Basics

Wireless technology is based on the propagation and reception of electromagnetic waves. These waves respond in different ways in terms of propagation, dispersion, diffraction and reflection depending on their frequency and the medium in which they are travelling.

To enable communication there should optimally be an unobstructed line of sight between the antennas of the devices. However, the so called *Fresnel Zones* should also be kept clear from obstacles, as radio waves reflected from objects within these zones may reach the receiver out of phase, reducing the strength of the original signal (also known as phase cancelling).

Fresnel zones can be thought of as ellipsoid three-dimensional shapes between two wireless devices. The size and shape of the zones depend on the distance between the devices and on the signal wave length. As a rule of thumb, at least 60 % of the first (innermost) Fresnel zone must be free of obstacles to maintain good reception.

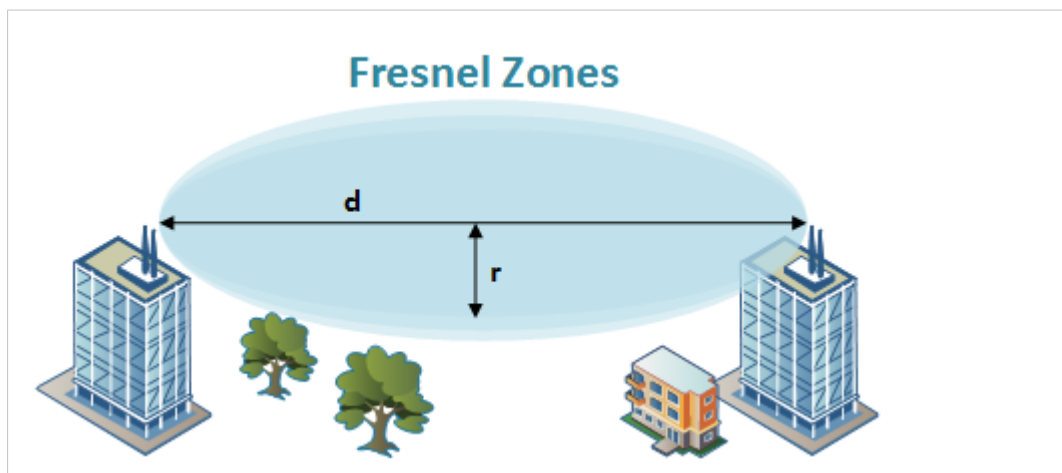

Fig. 26 Fresnel zones

Area to keep clear of obstacles (first Fresnel zone)

Distance (d)	Fresnel zone radius (r)	
	2.4 GHz (WLAN or Bluetooth)	5 GHz (WLAN)
100 m	1.7 m	1.2 m
200 m	2.5 m	1.7 m
300 m	3.0 m	2.1 m
400 m	3.5 m	2.4 m

The wireless signal may be adequate even if there are obstacles within the Fresnel zones, as it always depends on the number and size of the obstacles and where they are located. This is especially true indoors, where reflections on metal objects may actually help the propagation of radio waves. To reduce interference and phase cancelling, the transmission power of the unit may in some cases have to be reduced to limit the range.

It is therefore recommended to use a wireless signal analysis tool for determining the optimal placement and configuration of a wireless device.

This page intentionally left blank

